

DSHP-7 THRU DSHP-10 HEAT PUMP SPECIFICATION

FOR INDOOR FRESH AND SALT WATER APPLICATIONS

REMOVABLE
BLACK ABS
COVER

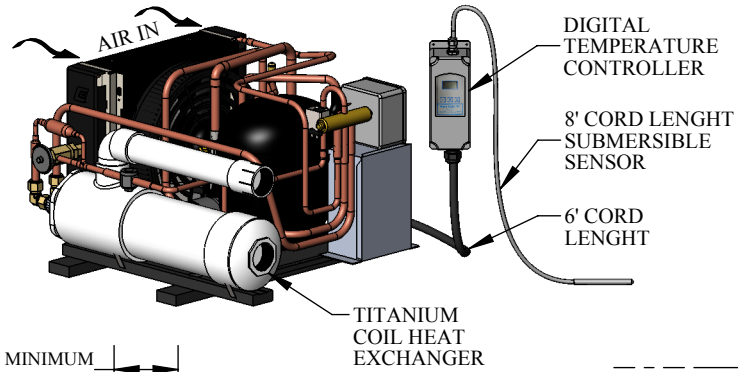

POWER CORD
PLUG TYPE



#5-20P
DSHP-7

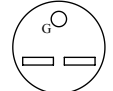

#6-15P
DSHP-8 THRU DSHP-10

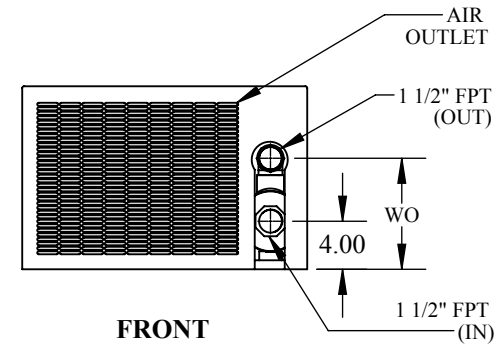
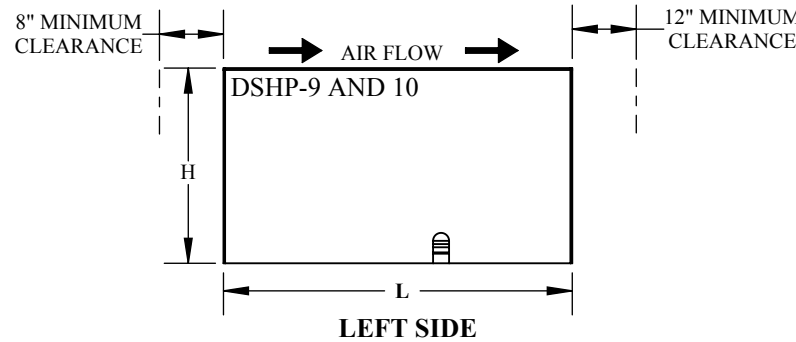
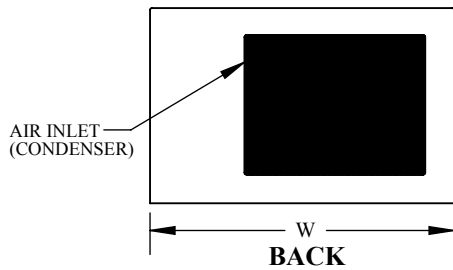
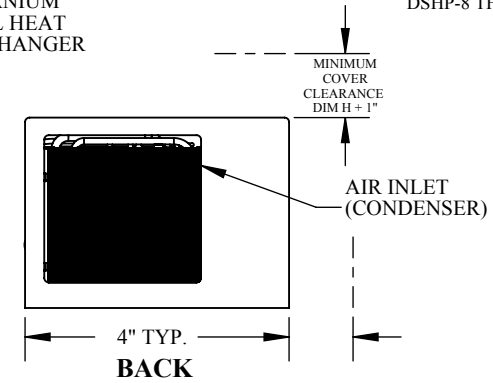
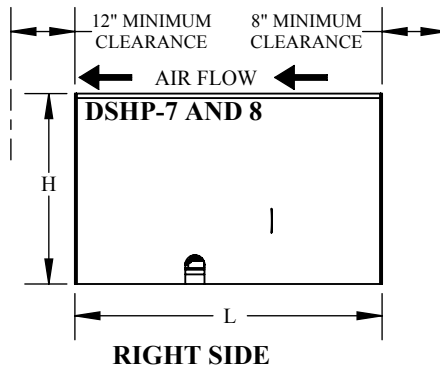
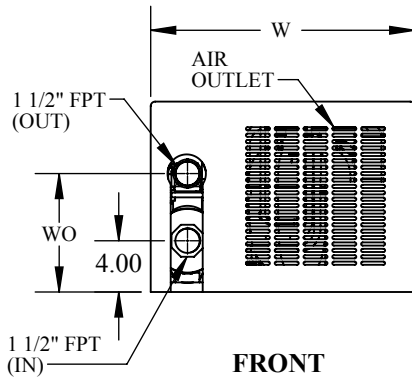

WO: WATER OUTLET

-ALL MODELS INCLUDES 18" LONG POWER CORD AND 6' CONTROL TETHER.

HEAT PUMP SPECIFICATIONS

MODEL NO.	HP	NOMINAL BTUH	REFRIGERANT TYPE / CHARGE (LBS.)	VOLTS / PHASE	WATTS	AMPS.	WATER FLOW RATE (GPM)	AIR OUTLET (CFM)	L	W	H	WO	SHIPPING WEIGHT (LBS.)	SHIPPING DIMENSION (IN.)
DSHP-7	3/4	9500	R134A / 3	115	1495	13	15 - 30	590	24"	21"	15"	9 1/4"	170	33 x 26 x 23
DSHP-8	3/4	9500	R134A / 3	230 / 1	1610	7	15 - 30	590	24"	21"	15"	9 1/4"	170	33 x 26 x 23
DSHP-9	1	12,000	R134A / 3.5	230 / 1	1656	7.2	20 - 35	610	27"	24"	15"	9 1/4"	180	33 x 26 x 23
DSHP-10	1 1/2	21,000	R417A / 4.5	230 / 1	2415	10.5	25 - 40	772	31"	26"	19"	12"	225	36 x 33 x 24

NOTE:

- DO NOT OPERATE IN HEAT MODE BELOW 55°F AIR TEMPERATURE.
- ALL MODELS MUST HAVE ACCESS FOR CLEANING CONDENSER.
- ALL DIMENSIONS ARE APPROXIMATE AND MAY CHANGE AT ANY TIME.

* COPYRIGHT *
These drawings including design idea and construction techniques herein are the sole property of Aqua Logic Inc. They shall not be revised, copied, or reproduced in any manner without the written consent of Aqua Logic Inc.

DESCRIPTION
DELTA STAR AIR COOLED HEAT PUMP

DRAWN BY Arnaldo Guzman	DATE 11/13/2015	REVISION	SCALE 1:15	SHEET # 1 OF 1
----------------------------	--------------------	----------	---------------	-------------------

DRAWING #
PDF-0103

SHEET TITLE
DSHP-7 THRU
DSHP-10
SPECIFICATIONS



9558 Camino Ruiz, San Diego, CA 92126